



***The Name for
Attenuators***

ALAN MODEL 50CA8-20 PM PANEL MOUNT CONTINUOUSLY VARIABLE ATTENUATOR ELECTRICAL SPECIFICATIONS	
FREQUENCY RANGE	4-8 GHz
IMPEDANCE	50 Ohms
ATTENUATION RANGE	0-20 dB minimum
INSERTION LOSS	0.75 dB
MAXIMUM SWR	1.5:1
AVERAGE POWER	5 Watts
CONNECTORS	SMA Female
DRIVE	Screwdriver adjustment with locking nut
MOUNTING CONFIGURATION	Panel Mount
TEST DATA	Supplied at no charge when requested prior to shipment. Please allow extra 1-3 business days for shipping.
COUNTRY OF ORGIN	USA
RoHS STATUS	RoHS Compliant Available in a Non-RoHS configuration as a build to order product. Please contact factory to order.

Alan

The Name for Attenuators

**Alan Industries, Inc. • 745 Greenway Drive • Columbus, Indiana 47201 • USA
800-423-5190 or 812-372-8869 • Fax: 812-372-5909
www.alanindustries.com • sales@alanindustries.com**



**The Name for
Attenuators**

PHYSICAL DIMENSIONS

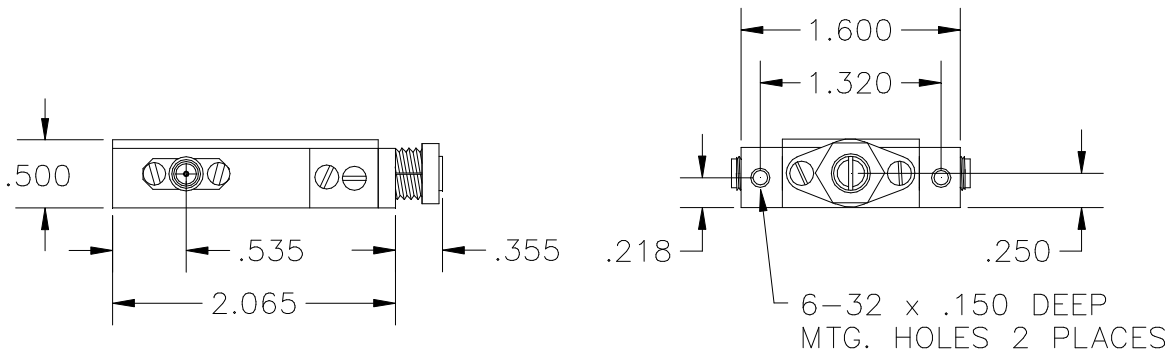
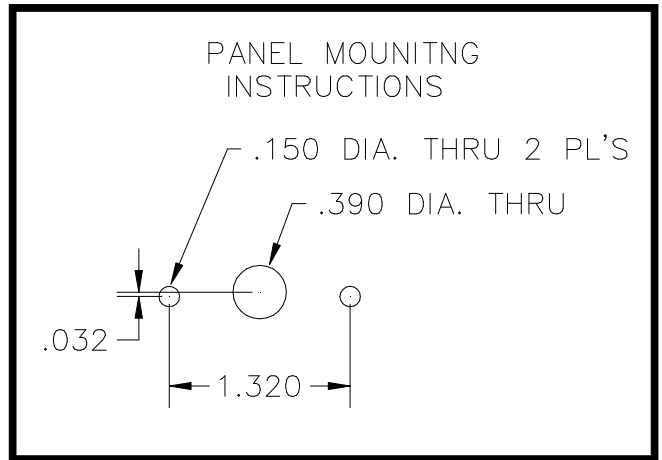
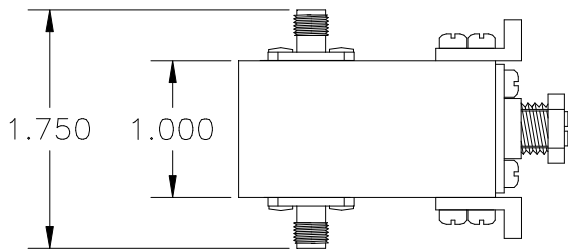

Alan

The Name for Attenuators

Alan Industries, Inc. • 745 Greenway Drive • Columbus, Indiana 47201 • USA
800-423-5190 or 812-372-8869 • Fax: 812-372-5909
www.alanindustries.com • sales@alanindustries.com